

**HYUNDAI**  
POWER PRODUCTS

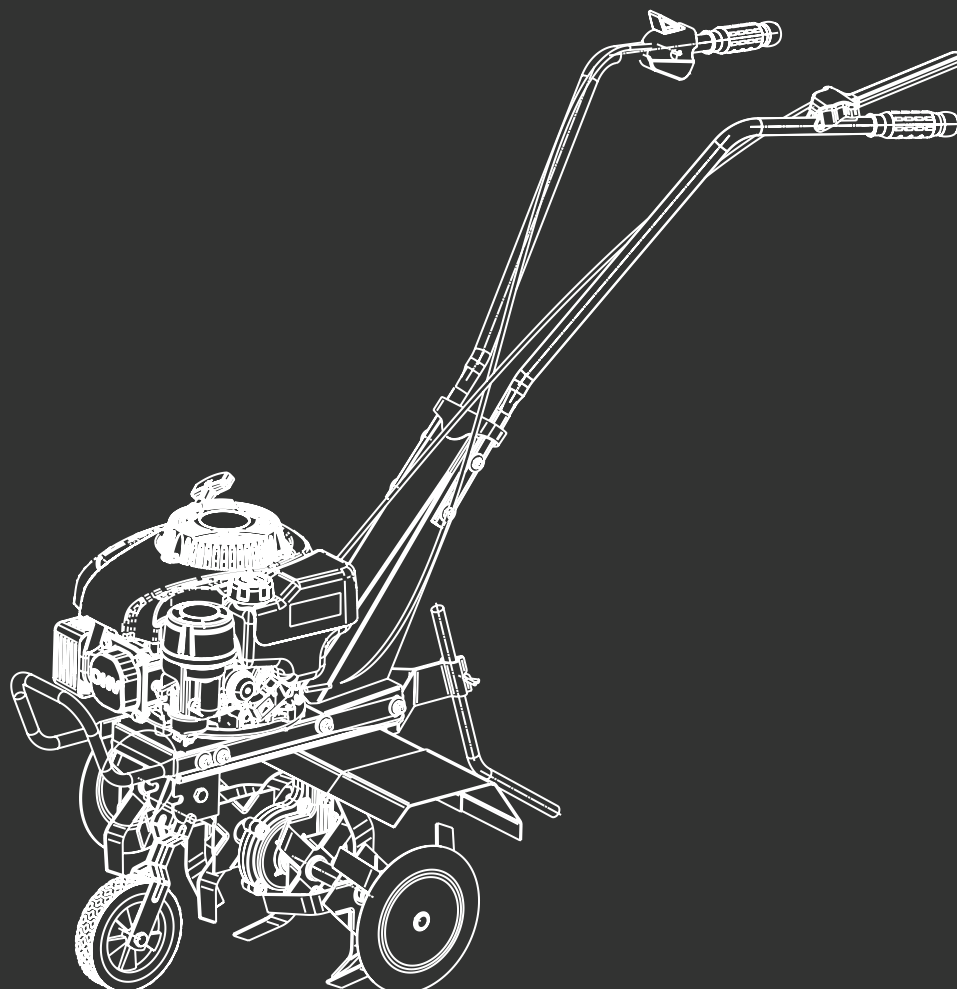

# PETROL ROTAVATOR/TILLER HYT150

Instruction Manual



# Introduction

## Thank You For Purchasing Your HYUNDAI Product

We work very hard to give all of our customers the best possible service. If you have any problems, before leaving negative feedback, please contact us to give us a chance to resolve the issue. We would be delighted if you left us positive feedback! Thank you for purchasing this product.

## Important!



**⚠WARNING : READ THE INSTRUCTION BOOKLET THOROUGHLY BEFORE USING THE MACHINE.** Keep for future reference and pass it on if the machine is loaned or sold to another user.

This manual has been produced by Hyundai Power Products and should be kept with the product. Please read and understand these instructions before you use your product. Failure to do this may result in personal injury or damage to the product.

The safety precautions and warnings are to ensure your safety and protect you from harm or damage to the product.

The information contained in this manual was accurate at the time of production, however HYUNDAI Power Products may make modifications to the product without notification.



# Contents

<b>Safety Information.....</b>	<b>4-18</b>	<b>Maintenance.....</b>	<b>32-42</b>
Understand Your Machine.....	4	Maintenance Safety.....	32
Intended Use.....	5	Checking Your Machine.....	32
Personal Safety.....	6	Maintenance Schedule.....	33
Inspect Your Machine.....	7	Air Filter Service.....	34
Work Area.....	8	Spark Plug Service.....	35
Electrical Safety.....	9	Draining The Oil.....	36
Batteries.....	9	Adding Gearbox Oil.....	36
During Use.....	10-11	Draining Gearbox Oil.....	37
Engine Safety.....	12	Cleaning.....	38
Carbon Monoxide.....	13	Transportation.....	39
Fuel Safety.....	14-15	Storage.....	40-41
Vibrations.....	16	Troubleshooting.....	42
Noise.....	16	<b>Technical Data.....</b>	<b>43</b>
Personal Protective Equipment.....	17	Specifications.....	43
Symbols On The Machine.....	18	Spare Parts.....	43
<b>Features.....</b>	<b>19</b>	<b>Recycling And Disposal.....</b>	<b>44</b>
<b>Unboxing.....</b>	<b>20</b>	<b>Declaration Of Conformity.....</b>	<b>45</b>
<b>Assembly.....</b>	<b>21-25</b>	<b>Notes.....</b>	<b>46-47</b>
Assembly Safety.....	21	<b>Useful Information.....</b>	<b>48</b>
Attaching The Handlebar.....	22	Our YouTube Channel.....	48
Attaching The Cable Clips.....	23	Warranty.....	48
Attaching The Drag Bar.....	23	Manual Updates.....	48
Attaching The Blades.....	24	Returning Your Product.....	48
Attaching The Mud Guard.....	25	Leaving A Review.....	48
<b>Preparation.....</b>	<b>26-27</b>	Ordering Spare Parts.....	48
Adding Oil.....	26	<b>Our Product Range.....</b>	<b>49</b>
Checking Oil Level.....	26	<b>Product Information.....</b>	<b>50</b>
Adding Fuel.....	27	Information.....	50
<b>Operation.....</b>	<b>28-29</b>	Service Record.....	50
Clutch Operation.....	28	<b>Contact Us.....</b>	<b>51</b>
Lifting front Wheel.....	28		
Handlebar Height Adjustment.....	29		
Tilling Depth Adjustment.....	29		
<b>Starting / Stopping.....</b>	<b>30-31</b>		
Starting.....	30		
Stopping.....	31		



# Safety Information

## Understand Your Machine

- **WARNING!** You must read these instructions carefully before operating the machine. Make sure that you are familiar with the controls and properly operate the machine. You must learn how to stop the machine quickly. If you do not follow the warnings and instructions, it may result in fire and/or serious injury. Make sure to save all warnings and instructions for future reference.
- Read this manual and labels affixed to the machine to understand its limitations and potential hazards.
- Be thoroughly familiar with the controls and their proper operation. Know how to stop the machine and disengage the controls quickly.
- If the unit is to be used by someone other than original purchaser, or is to be loaned, rented, or sold, always provide this manual and any needed safety training before operation. The user can prevent and is responsible for accidents or injuries that may occur to themselves, to other people, or to property.
- Do not force the machine beyond its limits. Use the correct machine for your application.
- Know how to stop the machine quickly in case of emergency. Understand the use of all controls.
- ALL MAINTENANCE other than that listed in this manual, should be carried out by professionally trained and certified personnel.



# Safety Information

## Intended Use

The HYT150 is a petrol cultivator/ tiller from Hyundai. The HYT150 has a tilling width of 560mm and is powered by a 150cc OHV 4-stroke petrol engine.

This machine is a garden tool and precisely a pedestrian controlled cultivator/tiller. The operator is able to operate the machine and use the main controls, always staying behind the handle at a safe distance from the rotating tines.

The machine is manufactured according to the latest safety requirements. Every precaution is only effective when it is followed exactly.

### Intended Use

The basic version of the equipment is a cultivator/tiller intended for private use, i.e. for use in home and gardening environments. It is designed to prepare the ground for flowers and vegetables.

### User Types

This machine is intended for use by consumers, i.e. non professional operators. The machine is intended for "DIY" and domestic use only.

### Improper Use

Any other usage not in keeping with the above mentioned ones may be hazardous and harm persons and/or damage things. Examples of improper use may include, but are not limited to:

- transporting people, children or animals on the machine
- letting yourself be transported by the machine
- using the machine to tow or push loads
- use of the machine by more than one person



# Safety Information

## ▲ Personal Safety

- **WARNING!** Never allow children or people unfamiliar with these instructions to use the product. Local regulations can restrict the minimum age of the operator.
- Keep children, pets, and other people not using the unit away from the work area. Be alert and shut off the unit if anyone enters work area. Keep children under the watchful care of a responsible adult.
- Stay alert, watch what you are doing and use common sense when operating the machine. Never operate the machine when unwell or tired, or if you have taken alcohol, medicine, drugs or any substances which may slow your reflexes and compromise judgment. A moment of inattention while operating the machine may result in serious personal injury.
- Appropriate Personal Protective Equipment (PPE), **MUST** be worn at all times when operating or repairing the machine. Always wear anti-slip and resistant work footwear and long trousers while using the machine. Do not use the machine when barefoot, wearing sandals or similar lightweight footwear. Do not wear chains, bracelets or clothing that is loose fitting or hanging ties or cords. Tie long hair back. Always wear protective earplugs. Loose clothes, jewellery, or long hair can be caught in moving parts. Protect eyes, face, and head from objects that may be thrown from the unit. Always wear safety goggles or safety glasses with side shields when operating.
- Always keep hands and feet away from all moving parts during operation. Moving parts can cut or crush body parts. Always keep hands and feet away from all pinch points.
- Do not touch parts that might be hot from operation. Allow parts to cool before attempting to maintain, adjust, or service.
- Do not overreach. Keep proper footing and balance at all times. This enables better control of the machine in unexpected situations. Extending your body too far can result in a loss of balance and you may fall which will result in injury.
- Never place any part of your body where it would be in danger if movement should occur during assembly, installation, and operation, maintenance, repairing or moving.
- Start the machine carefully according to instructions and with feet away from the moving parts.
- Do not place your hands or feet near or under rotating parts. Keep away from any discharge openings.
- Keep in mind that the operator or user is responsible for accidents, hazards or unexpected events involving the machine that occur to other people or their property. It is the responsibility of the user to assess the potential risk of the area where work is being carried out. The operator or user must take all necessary precautions to ensure their own safety and that of others, especially on slopes or rough, slippery and unstable ground.



# Safety Information

## **▲ Inspect Your Machine**

- Check your machine before starting it. Keep guards in place and in working order. Make sure all nuts, bolts, etc., are securely tightened.
- You must check the general condition of the machine before use.
- Never operate the machine when it is in need of repair or is in poor mechanical condition. Replace damaged, missing, or failed parts before using it. Check for fuel leaks. Keep the machine in safe working condition.
- Do not use the machine if the engine's switch does not turn off the engine when running. Any petrol powered machine that can't be controlled with the engine switch is dangerous and must be replaced.
- Regularly check to see that keys and adjusting wrenches are removed from the machine area before starting it. A wrench or a key that is left attached to a rotating part of the machine may result in personal injury.
- If the machine should start to vibrate abnormally, stop the engine and check immediately for the cause. Vibration is generally a warning sign of trouble.
- Avoid accidental starting. Be sure the engine's switch is off before transporting the machine or performing any maintenance or service on the unit. Transporting or performing maintenance or service on a machine with its switch on invites accidents.
- Do not tamper with or disable safety systems.
- Only use manufacturer-recommended attachments.
- Before using, always visually inspect to see that the tools are not worn out or damaged. Replace worn out or damaged elements and bolts in set to preserve balance.
- Keep all nuts, bolts and screws tight to ensure the equipment is in safe working condition.
- Keep the machine in good operating condition. Operating the machine in poor or questionable condition could result in serious injury.
- Be sure all safety devices are in working order and warning labels are in place. These items are installed for your safety.



# Safety Information

## Work Area

- Make sure you thoroughly inspect the entire work area and remove all objects and anything that could be thrown by the machine or could damage the engine or machine (branches, stones, wire, toys, etc). Attempting to clear the work area whilst using the machine will reduce your concentration and creates a trip hazard. Any liquid spilled on the floor may result in you slipping.
- You must only work in daylight or with good artificial light in good visibility conditions. Keep people, children and animals away from the working area.
- Operate on flat, level ground.
- DO NOT work on wet ground. If there has been heavy rain on the working site, wait until the ground has dried up.
- You must pay special attention when approaching obstacles that could compromise visibility.
- Exercise extreme caution when changing direction on slopes. When changing direction, you need to be careful that the wheels do not hit any obstacles (such as roots, branches, stones, etc) that can cause the machine to slide sideways or make you lose control of it. Avoid driving on slopes steeper than 15%. Make sure on slopes you have a steady foothold.
- Find and locate all fixed objects in the ground, such as sprinkler systems, poles, water valves, bases for washing lines etc. Make sure that you check for hidden electrical cables or similar on the surface of the lawn. ALWAYS run the machine around these objects. NEVER intentionally run the machine over foreign objects.
- Never park the machine in a place with unstable ground which could give way.
- You must be careful near ravines, ditches or embankments.
- Exercise extreme caution when operating on or crossing gravel drives, walks, or roads. Stay alert for hidden hazards or traffic.
- Pay the utmost attention when working on frozen ground as the machine may tend to skid.
- Do not work in the rain or when there is a thunderstorm or lightning risk. If there is bad weather conditions, do not use the machine.





# Safety Information

## ⚠ Electrical Safety (Where Applicable)



**DANGER!**

**ELECTRICITY CAN KILL - NEVER WORK ON LIVE/ENERGISED EQUIPMENT.**

- Prior to carrying out any maintenance work you **MUST** identify electrical isolation methods and isolate all electrical supplies.
- Prior to use and with all electrical supplies isolated, you **MUST** check all electrical cables, plugs and connectors for the following;
  - Are intact and have no signs of damage, to include but not limited to bare wires, chaffing, cuts and loose wiring.
  - If there are any signs of damage, the damaged item **MUST** be taken out of service until the damage has been repaired by an electrically competent person.
  - All trailing cables should be routed so as not to cause any kind of trip hazard.
  - **NEVER** work on or near electricity with wet hands, wet clothing and wet gloves.

## ⚠ Batteries (Where Present)

Batteries present a risk if they become damaged by the possible leaking of electrolyte. This electrolyte is an acid and can cause serious burn injuries. Care should be taken when working on or near them. **NOTE** the electrolyte may be in a liquid or gel form.

Should you come in to contact with electrolyte you should;

- Remove all clothing contaminated with electrolyte. If you cannot remove then saturate them in water.
- Get medical assistance as soon as possible.

You must advise the medical staff of the type of acid.

- Lead/acid battery = dilute sulphuric acid.
- Nickel/cadmium = potassium hydroxide alkali electrolyte.
- Use fresh running water to wash off excess electrolyte, continue this until medical assistance arrives. Make sure that you do not wash the electrolyte to another part of your body or face.
- If electrolyte comes in to contact with eyes the electrolyte needs to be immediately washed away with large amounts of water. Make sure that you do not wash the electrolyte to another part of your face or body.
- Gasses from charging batteries are highly flammable and great care should be taken to charge in well ventilated areas.



- There is an explosion risk if the battery terminals are short circuited, when connecting/disconnecting **ALWAYS** exercise great care so that the terminals or battery leads are **NOT** allowed to touch and cause a spark. **ALWAYS** use suitable insulated tools.



# Safety Information

## During Use

- Always hold the unit with both hands when operating. Keep a firm grip on the handlebars. Be aware that the machine may unexpectedly bounce upward or jump forward if the machine should strike buried obstacles such as large rocks or roots.
- Do not operate the machine in confined areas where there may be a risk of crushing the operator between the machine and another object.
- Walk, never run with the machine. Be very careful when pulling the machine toward you. You must look behind you to make sure there are no obstacles before and during operations. Do not allow the machine to pull you along.
- **WARNING!** If something breaks or an accident happens whilst working, you must turn off the engine immediately and move the machine away to prevent further damage. If an accident happens with injuries or third parties are injured, carry out the first aid measures most suitable for the situation immediately and contact the medical authorities for any necessary health care. Carefully remove any debris that might cause damage or harm persons or animals should it not be seen.
- Keep a firm hold on the handlebars, they may tend to lift during clutch engagement.
- Do not carry passengers.
- Never operate the machine at a fast pace.
- The excessive speed of movement or the absence of maintenance have a significant influence on noise emissions and vibrations. It is necessary to take preventive steps to eliminate possible damage due to high levels of noise and stress from vibration. You must maintain the machine well, wear ear protection and take breaks from working.
- After striking a foreign object, stop the engine immediately, remove the spark plug cap and inspect the machine thoroughly for damage. Repair the damage before continuing.
- Always disengage the levers, turn off the engine, and remove the spark plug, when the unit is left unattended.
- Never attempt to make any adjustments, while the engine is running.
- When the rotor is clogged with mud, pebble etc, immediately stop the engine and clean the rotor in a safe place. Be sure to wear heavy gloves when cleaning the rotor.
- Adjust rotating depth according to the condition of the ground. Hoe hard ground in progressive stages.
- Do not use the tiller with a rotor with diameter over 260mm.



# Safety Information

- Objects hit by the rotating tines can be thrown from the tiller with great force and may cause severe injury.
- Never attempt to move the machine in any way other than intended for normal use while the engine is running.
- Always turn off the engine and ensure that all moving parts have come to a complete stop before making any repairs, adjustments, or inspections.
- Before leaving the machine to clear blockages, check, clean, refuel or after striking foreign object, stop the engine and make sure that the blades have come to a complete stop.
- You must disengage the blade, switch off the engine and unplug the spark plug cable (making sure that all moving parts are stationary):
  - Before refuelling.
  - Before adjusting the cutting height.
  - After striking a foreign object, you must inspect the machine for damage and make repairs before using it again.
  - Before checking or working on the machine.
  - Before clearing blockages.
  - When transporting the machine.
  - Whenever you leave the machine unattended.



# Safety Information

## **⚠ Engine Safety**

- This machine is equipped with an internal combustion engine. Do not use on, or near, forest-covered or brush-covered land unless the exhaust system is equipped with a spark arrester meeting applicable local, state, or federal laws.
- A spark arrester, if used, must be maintained in effective working order by the operator.
- Never start or run the engine inside a closed area. The exhaust fumes are dangerous, containing carbon monoxide, an odorless and deadly gas. Operate this unit only in a well-ventilated outdoor area. (See carbon monoxide safety).
- Do not tamper with the engine in an effort to get it to run at higher speeds. The maximum engine speed is preset by the manufacturer and is within safety limits.
- Keep a fire extinguisher on hand when operating this machine in dry areas as a precautionary measure.
- Never leave the operating position when the engine is running.
- The engine parts get very hot when running, do not touch. Danger of burns.
- Follow the instructions to ignite the engine carefully whilst keeping feet away from moving parts.
- Never incline the machine during ignition. Ignite the machine on a flat surface without obstacles or high grass.
- Do not over-rev the engine or change the engine settings.
- Never pick up or carry the machine while the engine is running.
- Stop the engine whenever you leave the machine, or before refuelling, when cleaning or while maintaining.
- Reduce the throttle setting during engine shut down and, if the engine is provided with a shut-off valve, turn the fuel off at the conclusion of working.
- Do not tilt the machine when starting the engine.



# Safety Information

## **⚠ Carbon Monoxide**

### **⚠ DANGER!**

**Engine exhaust fumes contain Carbon Monoxide. This is a poisonous gas and can kill in minutes. NEVER use inside a building or in an area with poor ventilation. NEVER use inside a confined space, such as but not limited to a house, garage, vehicle, boat or tent. ONLY use outside and far away from windows, doors and vents.**

**CARBON MONOXIDE IS A COLOURLESS, ODOURLESS GAS. INHALING THIS GAS CAN CAUSE DEATH OR SERIOUS LONG-TERM HEALTH PROBLEMS SUCH AS BRAIN DAMAGE.**

Never operate the engine in a confined space where dangerous carbon monoxide fumes can develop. All ignition operations have to be effected in an open or well-ventilated area. Always remember that exhaust fumes are toxic.

The symptoms of carbon monoxide poisoning can include but are not limited to the following; Headaches, dizziness, nausea, breathlessness, collapsing or loss of consciousness.

Carbon monoxide poisoning symptoms are similar to flu, food poisoning, viral infections and simply tiredness. It is quite common for people to mistake this very dangerous poisoning for something else.

To avoid carbon monoxide poisoning **DO NOT** use Petrol/Diesel powered equipment inside any of the following; Home, garage, tent, camper van, mobile home, caravan or boat. **DO NOT** use in an enclosed area or moving vehicle. This is not exhaustive and if you are in any doubt contact your dealer.

If you think you have or someone around you has been affected by carbon monoxide poisoning; Get them fresh air immediately, by leaving the affected area or by opening doors and windows. If safe and practical to do so make sure that the machine is turned off. **DO NOT** enter a room you suspect of having carbon monoxide present – instead call the emergency services.

Contact a Doctor immediately or go to Hospital – let them know that you suspect carbon monoxide poisoning.



# Safety Information

## ▲ Fuel Safety



**CAUTION! ALL FUELS ARE HIGHLY FLAMMABLE AND PETROL VAPOUR IS EXPLOSIVE. TAKE EXTREME CARE WHEN HANDLING FUEL. KEEP FUEL OUT OF REACH OF CHILDREN.**

## General Safety

- Do not smoke each time fuel is handled.
- ALWAYS avoid inhaling fumes.
- ALWAYS carry fuel in the correct and clearly marked container.
- ALWAYS wear correct, suitable and fit for purpose Personal Protective Equipment (PPE), suggested items are but not limited to safety gloves and overalls.
- To avoid sparking or arcing, keep grounded conductive objects – such as tools – away from exposed, live electrical parts and connections. These events could ignite fumes or vapors.
- Do not operate the machine with known leaks in the fuel system.
- Fire hazard - keep fuel away from all sources of ignition for example heaters, lamps, sparks from grinding or welding.
- DO NOT carry out hot work on tanks that have contained fuel.
- ALWAYS keep the work area tidy.
- ALWAYS dispose of waste fuels correctly.
- Serious personal injury can occur when petrol is spilled on yourself or your clothes. Rinse your skin and change your clothes immediately.

## Spilled Fuel

- If you have spilled fuel, make sure you do not attempt to ignite the engine but move the machine away from the area of spilled fuel and avoid creating any source of ignition until the fuel has evaporated and fuel vapours have dissipated.
- When fuel is spilled on yourself or your clothes, wash your skin and change clothes immediately.
- ALWAYS clean up spills promptly using absorbent granules and a lidded bin.



# Safety Information

## Fueling / De-Fueling

- ALWAYS fuel and de-fuel in a well ventilated area outside of buildings. Use a funnel to add fuel, only outdoors. Do not smoke during this and each time fuel is handled.
- Add fuel before igniting the engine, never remove the fuel tank cap or add fuel whilst the engine is running or when it is hot.
- When de-fueling ALWAYS use a proper fuel retriever.
- Never overfill the fuel tank. Engine heat can cause fuel to expand, never fill the tank to more than 1/2" below the bottom of the filler neck. This will provide space for fuel expansion.
- When refilling or draining the fuel tank, use an approved fuel storage container while in a clean, well-ventilated outdoor area. While adding fuel or operating the unit, do not smoke, and stay away from sparks, open flames, or other sources of ignition near the area of operation.
- Always stop the engine and allow it to cool before filling the fuel tank. Never remove the cap of the fuel tank or add fuel while the engine is running or when the engine is hot.
- Loosen the fuel tank cap slowly to relieve any pressure in the tank.
- ALWAYS keep the handles dry, clean and free of oil and fuel.
- After fueling, ensure to tighten the cap securely.
- Never use the lock-function when filling with fuel.

## Storage

- Store fuel in containers specifically designed and approved for fuel storage.
- Store fuel in a cool, well-ventilated area, safely away from sparks, open flames, or other sources of ignition.
- Never store fuel – or a machine with fuel in the tank – inside a building where fumes may reach a spark, open flame, or any other source of ignition (such as a water heater, furnace, or clothes dryer). Allow the engine to cool before storing in any enclosure.
- Replace all fuel tank and container caps securely and wipe up spilled fuel. Never operate the unit without the fuel cap securely in place.



# Safety Information

## ⚠ Vibrations (Where Applicable)

- Prolonged use of hand held (operated) machines will cause the user to feel the effects of/from vibrations. These vibrations can lead to white finger (Raynaud's phenomenon) or carpal tunnel syndrome. This condition reduces the ability of the hand to feel and regulate temperature, causing numbness and heat sensations and may cause nerve damage and circulatory tissue death.
- Not all factors that lead to white finger disease are known, but cold weather, smoking and other diseases that affect blood vessels and blood circulation as well as large and long-lasting impact of shocks are considered factors in the formation of white finger. Note the following to reduce the risk of white finger and carpal tunnel syndrome;
  - Wear gloves and keep your hands warm.
  - Take regular breaks.
  - All of the above precautions may help reduce the risk of white finger disease but not rule out the carpal tunnel syndrome. Long-term and regular users are therefore recommended to observe the condition of your hands and fingers. Seek medical attention immediately if any of the above symptoms should occur.

## ⚠ Noise (Where Applicable)

- The operating noise of the machine can damage your hearing. When wearing protection such as earplugs or ear defenders to protect your hearing. Long-term and regular users are advised to have hearing checked regularly. Be especially vigilant and cautious when wearing ear protection because your ability to hear alarm warnings will be reduced.
- Noise emissions for this equipment is unavoidable. Carry out noisy work at approved times and for certain periods. Limit the working time to a minimum. For your personal protection and protection of people working nearby it is also advisable for them to wear hearing protection.



- See Certificate of Conformity section for Outdoor Noise declaration of conformity.





# Safety Information

## ⚠ Personal Protective Equipment

Appropriate Personal Protective Equipment (PPE), **MUST** be worn at all times when operating or repairing the machine. No protective equipment can ensure 100% protection.

When selecting PPE, make sure it's CE marked and it suits the user in terms of size, fit, etc. If more than one item of PPE is worn at the same time, make sure they can be used together, e.g. wearing safety glasses may disturb the seal of a respirator, causing air leaks.



### **HAND PROTECTION MUST BE WORN**

Protective electrically non-conductive gloves are highly recommended when working.



### **FOOT PROTECTION MUST BE WORN**

Non-skid heavy duty footwear are highly recommended when working.



### **HEARING PROTECTION MUST BE WORN**

Suitable safety hearing protection is recommended.



### **EYE PROTECTION MUST BE WORN**

Always wear safety glasses/goggles and/or face shields. Everyday eyeglasses have only impact resistant lenses; they are not safety glasses/goggles.



### **PROTECTIVE CLOTHING MUST BE WORN**

Do not wear loose clothing, gloves, scarfs, neckties or jewellery (rings, wrist watches), which can be caught in moving parts.



### **HEAD PROTECTION MUST BE WORN**

Wear a safety helmet with a safety visor.



### **FACE SHIELD MUST BE WORN**

Wear a face shield to protect your face.



### **RESPIRATOR MUST BE WORN**

Wear a respirator.



# Safety Information

## Symbols On The Machine

We have provided safety messages in this manual and on the machine. This information alerts you to potential hazards that could hurt you or others. Please read these messages carefully. However, we may not have listed all of the possible hazards, you must also use your own judgment.



### IMPORTANT

Please read this instruction manual carefully, especially the safety warnings marked with the symbol.



### EYE PROTECTION

Always wear safety glasses/goggles and/or face shields. Everyday eyeglasses only have impact resistant lenses; they are not safety glasses/goggles.



### INSTRUCTION MANUAL

Read and understand operator's manual before using the machine. Failure to follow instructions could result in death or serious injury.



### DANGER OF THROWN OBJECTS

If approached by bystanders, stop the machine immediately.



### DO NOT SMOKE

No open flame; open ignition source and smoking prohibited.



### CAUTION! HOT SURFACE

Hot temperature, do not touch.



### DANGER AREA

Keep bystanders away, especially children and pets at least 15m away.



### WARNING

Keep feet away from sharp rotating blades.



### HAND PROTECTION

Protective gloves are highly recommended when working.



### NOISE MARKING

Single value noise marking (maximum declared A-Weighted sound power level in decibels).



### FOOT PROTECTION

Non-skid heavy duty footwear are highly recommended when working.



### CE SYMBOL

This product complies with the applicable European directives and an evaluation method of conformity for these directives was done.



### HEARING PROTECTION

Suitable safety hearing protection is recommended.



# Features

## HYT150 Features

This diagram is illustrative only and is intended to help you better understand the operating instructions. Actual product may vary. Subject to change.

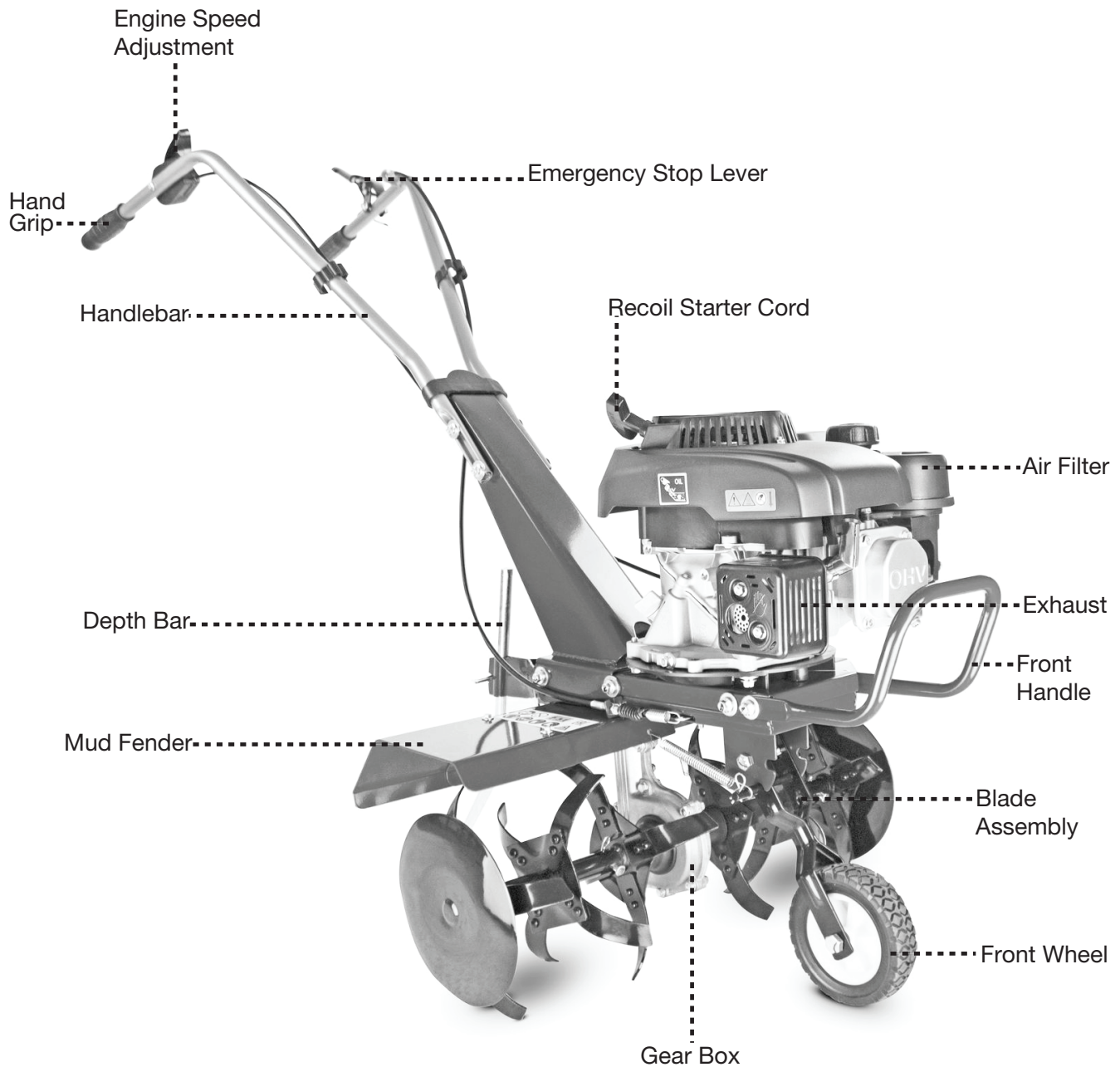

# Unboxing

## ⚠ Unboxing Safety

**⚠ WARNING!** Unboxing and assembling the machine should be done on a flat, stable surface with enough room. Disposal of the packaging should be done in accordance with the local regulations in force.

**⚠ WARNING!** Some of the packaging material may be harmful to children. Keep out of reach of children.

Carefully remove the product from the packaging and examine it for any sign of damage caused during shipping. Lay the contents out and check them. If any part is damaged or missing, you must not use the machine. Contact HYUNDAI Power Products immediately. You must keep the packaging material in case the machine needs to be returned or repaired.

Ensure that you have all the accessories and tools you need for assembly and operation including the suitable personal protective equipment.

## In The Box

- Main assembly plus handles
- Handle assembly bolts
- Cable clips
- Mud guard extension assembly
- Blade extensions
- Drag bar
- Handle bar support
- Drag bar connecting pin
- User Manual



# Assembly

## ⚠ Assembly Safety

**⚠CAUTION** - This guide is meant to serve as a quick reference for operating your HYUNDAI machine. We always advise reading the manual in full before operation.

**⚠CAUTION** - For OUTDOOR use ONLY. Petrol machines produce carbon monoxide – poisonous, colourless and odourless gas that can cause serious injury or death. Petrol is highly flammable, always handle with extreme care and in a well ventilated area.

**⚠NOTE** - Images may vary depending on model.

**⚠NOTE** - The machine can be supplied with some parts already assembled. Prior to assembly, check all items have been received.

**⚠NOTE** - This machine is shipped without fuel and oil and MUST be filled before use. Failure to do so may cause damage to the engine that will not be covered by warranty.

**We recommend that you fill out the information on page 50. If you need to contact an authorised dealer or customer service for information on servicing, you may need to provide this information.**

**There is also a service record so you can keep track of your machine service dates.**



# Assembly

## Unboxing & Assembly Video:

Go to [youtube.com](https://www.youtube.com) and type in Hyundai HYT150 unboxing & assembly.

**YOU MUST read and understand the instruction manual first.**

## Step 1 : Attach The Handlebar

- 1 Slide the handle bracket (25) onto the ends of the handles. Attach the handle bars to the handle bar support with bolts only finger tight to the lower position. **See image 1.**
- 2 Swing the handles up, and slide the bracket (25) down onto the handle support. Insert centre bolt and tighten. **See image 2.**
- 3 Insert the bolts through the upper holes. Tighten all bolts. **See image 3.**

Image 1



Image 2



Image 3



# Assembly

## Step 2 : Attach The Cable Clips

- 1 Attach the cables onto the handles using the clips (22) provided.

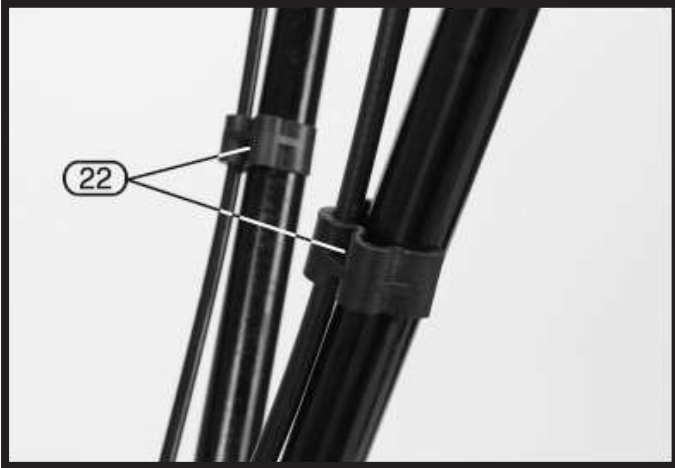

## Step 3 : Attach The Drag Bar

- 1 Attach the drag bar (18) to the drag bar holder, choose a suitable height and then lock the drag bar with the large R shaped-pin (26).

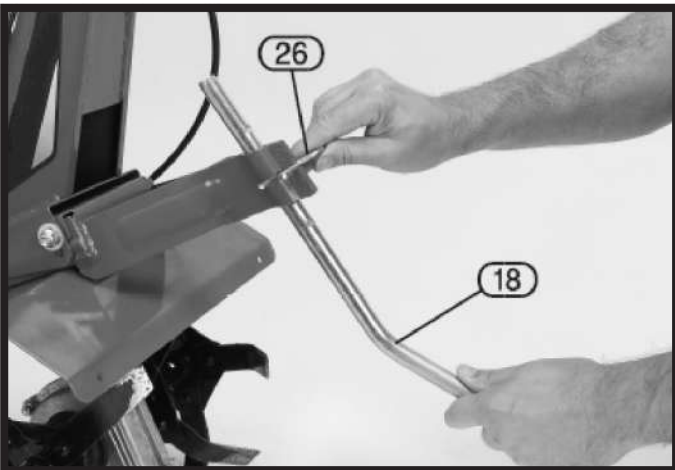



# Assembly

## Step 4 : Attach The Blades

- 1 Slide a blade (24.1) onto the end of the other blades shaft insert and secure with a R-type locking pin (24.2).
- 2 Slide the outer blade (24.3) into the outer blade hole, insert pin and secure with another R-type locking pin. Attach the blade to the opposite side of the rotavator shaft using the same method.

Image 1

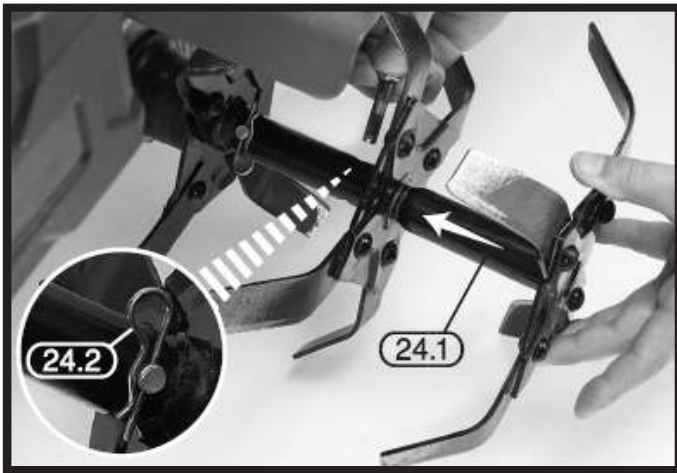
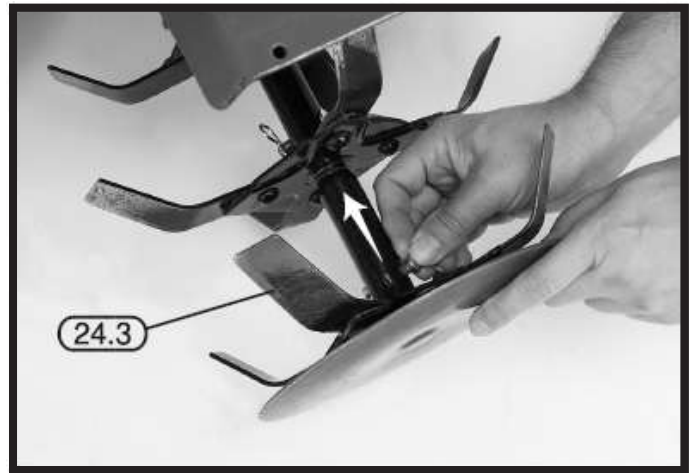

Image 2





# Assembly

## Step 5 : Attach The Mud Guard

- 1 Attach the mud guard (23) to both sides with the nuts and bolts supplied and tighten.



# Preparation

**⚠ CAUTION** - Do not make any adjustment to the machine without stopping the engine first. Running the engine with low oil level will cause serious engine damage.

## Adding Oil

Oil Type : SAE 30 or 15W40 Engine Oil  
Oil Capacity : 0.4L

**NOTE** - The machine is delivered without oil in the engine. All machines are tested and inspected so there may be some residual oil left in the machine so please fill with caution.

- 1 Remove the oil filler cap.
- 2 Fill with fresh SAE 30 or 15W40 engine oil to the upper mark on the dipstick. DO NOT overfill.
- 3 Once the correct amount of oil has been added, refit the dipstick securely.



## Checking Oil Level

- 1 Remove the oil filler cap and wipe the dipstick clean.
- 2 Refit the dipstick without screwing it down. Remove the dipstick and check the oil level. It should be to the middle of the dipstick.
- 3 If the oil level is too low, add SAE 30 or 15W40 engine oil to the upper mark on the dipstick. DO NOT overfill. The oil level should not be above the upper mark on the dipstick.



- 4 Once the correct amount of oil has been added, refit the dipstick securely.

# Preparation

## Adding Fuel



Make sure you read the fuel safety before handling fuel.

Fuel Type : Fresh Straight Unleaded Petrol  
Fuel Capacity : 0.8L

**NOTE** - The machine is delivered without petrol. All machines are tested and inspected so there may be some residual petrol left in the machine so please fill with caution.

- 1 Remove the fuel tank cap.
- 2 Fill the fuel tank with fresh straight unleaded petrol. Allow a 25mm gap from the top of the tank, then refit the cap securely. **DO NOT** mix petrol with oil and clean up any spills immediately.

**NOTE** - **DO NOT** overfill. The fuel tank only needs to contain enough fuel to complete the days work. If you run out of fuel, refilling must only be done once the engine has cooled down. Fuel stored within the machine for 28 days or more can go stale and should be drained before further use.

**NOTE** - Make sure not to drip petrol onto the plastic parts to prevent damaging them and remove all traces of spilt petrol immediately. The warranty will not cover damage to plastic parts caused by petrol.

- 3 Refit the fuel filler cap securely and clean up any fuel spilt before starting the engine.



# Operation

## Clutch Operation

The clutch engages and disengages the power from the engine to the transmission.

- 1 The clutch lever (1) has a safety clip (1.1) which needs to be released before the clutch lever can be depressed.
- 2 Squeeze the clutch lever, and the rotating blades will rotate, release the clutch and they will stop.

Image 1

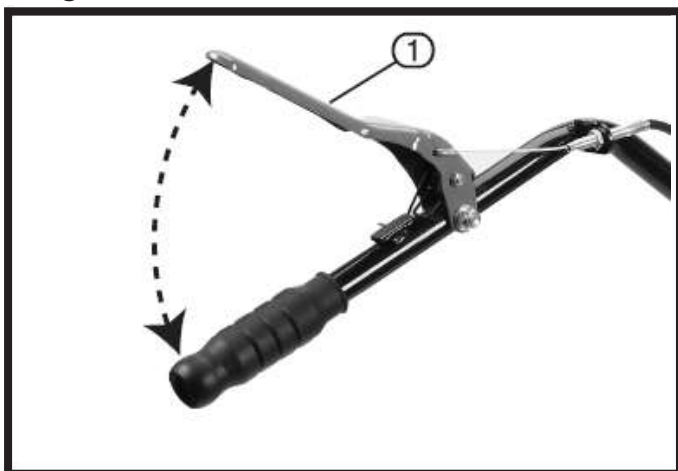

Image 2



## Lifting Front Wheel

When the tiller is in location ready to be used, lift the front wheel to the raised location.

- 1 Pull the front wheel bracket out of the location notch, swing the bracket down (the spring will pull the bracket back into the notch). The tiller can stand with no other support.
- 2 With the wheel in the lower position the tiller can be wheeled into position, lift the handlebars up and ground the front wheel. When the tiller is positioned and ready to use, then the front wheel can be lifted into the raised position.

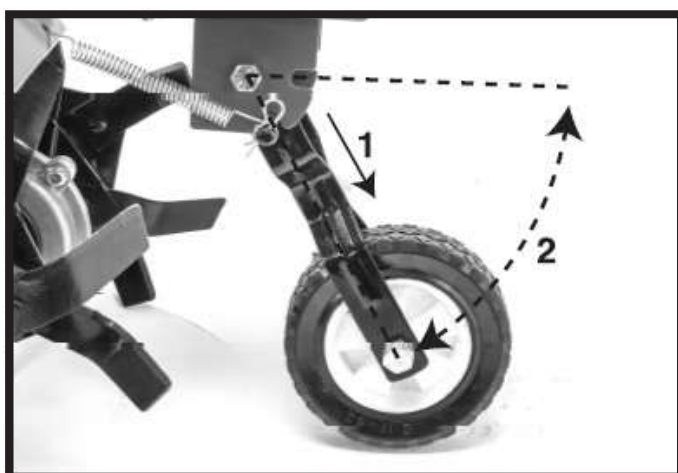

# Operation

## Handlebar Height Adjustment

**⚠ CAUTION!** Before adjusting the handlebar, place the tiller on firm level ground.

- 1 To adjust the tiller height, loosen the adjuster bolts (16) either side, select the appropriate height and tighten the bolt. Adjust the handlebar height to a comfortable position (usually waist height is recommended).

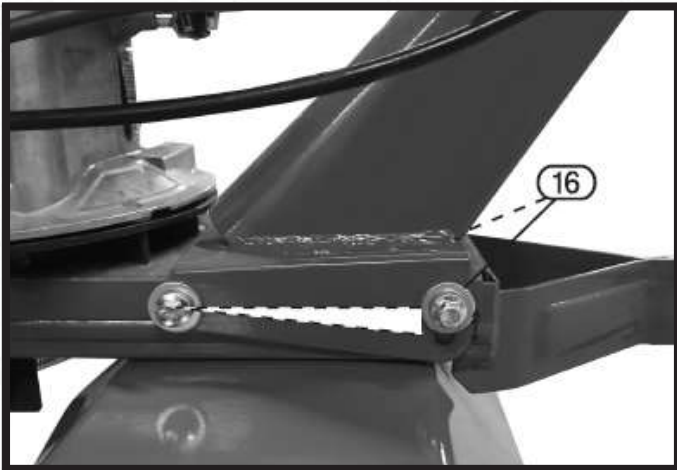

## Tilling Depth Adjustment

- 1 First attach the drag bar (18) into the drag bar holder, slide through to the required height and then lock the bar with the R-type locking pin.

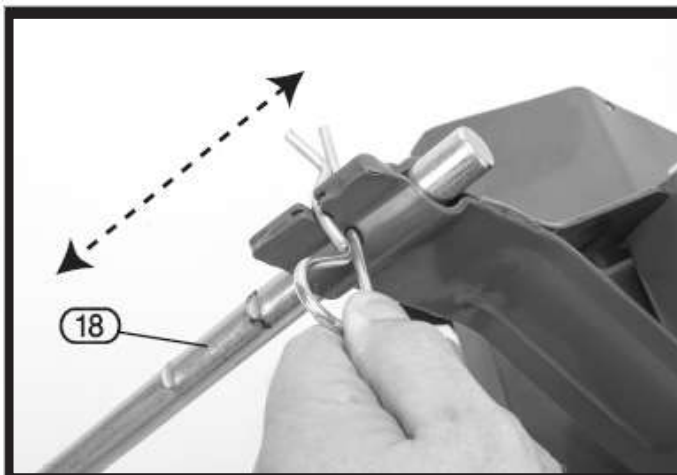

# Starting / Stopping

## Starting

- 1 Pull the engine lever up slightly to 'START RUN' position (4). **See image 1.**
- 2 Press the primer bulb three times to prime the motor. **See image 2.**
- 3 Pull the starter grip lightly until resistance is felt then pull rapidly. **See image 3.**

Image 1



Image 2



Image 3



# Starting / Stopping

## Stopping

**⚠ CAUTION** - The engine and exhaust will remain hot for a while after use. Ensure the engine and exhaust has cooled before carrying out any maintenance, refuelling or storage.

- 1 Disengage the clutch.
- 2 Push the engine switch/choke lever (5) to 'STOP' position.





# Maintenance

## ⚠ Maintenance Safety

**⚠ IMPORTANT** - Routine and accurate maintenance is essential for maintaining original machine safety and performance levels.

**⚠ WARNING** - Before cleaning or doing maintenance work, you need to stop the engine, disconnect the spark plug cable and read the relevant instructions. You need to wear proper clothing and protective gloves whenever your hands are at risk.

**⚠** If there are worn or damaged parts, never use the machine. Faulty or worn-out parts must be replaced and not repaired. You must only use original spare parts. The use of non-original and/or incorrectly fitted parts will jeopardize the safety of the machine. This may also cause accidents or personal injuries for which the manufacturer is under no circumstance liable or responsible.

**⚠** Any maintenance operations or adjustments not explained in this manual must be carried out by your Dealer or a specialised Service Centre with the necessary knowledge and equipment to ensure that the work is done correctly maintaining the machine's original safety level. Any operations performed in unauthorised centres or by unqualified persons will invalidate the Warranty and all obligations and responsibilities of the Manufacturer.

**⚠** Be very careful during adjustment of the machine to prevent entrapment of the fingers between moving parts and fixed parts of the machine.

## Checking Your Machine

When checking your machine, we recommend you:

- Check for worn or damaged parts
- Make sure all nuts, screws and bolts are tight
- Make sure all warning stickers are in place and not damaged
- Check for oil / fuel leaks



# Maintenance

## Maintenance Schedule

Routine and accurate maintenance is essential for maintaining original machine safety and performance levels.

It is recommended that the following maintenance schedule is followed.

Item		Every use	Every 3 months or 15 hours	Every 6 months or 50 hours	Every 12 months or 100 hours	Every 24 months or 300 hours
Air filter	Check	X				
	Clean		X*			
Spark plug	Check / Adjust				X	
	Replace					X
Carburettor	Clean		X			
Engine oil	Check	X				
	Change			X		
Cutting blades (tines)	Check	X	Replace as required			
Clutch	Check	X				
	Adjust		As required			
Drive belt	Replace as required	Contact dealer				
Gear box oil	Check level		X Fill as required			
Mechanical connections	Check / Tighten	X				
Fuel tank	Examine				X	
Fuel pipes	Examine	Each time, replace as required				

\* Clean more in dirty and dusty environments.

 **CAUTION!** For your own safety, turn the tiller off before any maintenance.

 **NOTE** - Where necessary, all corrective actions should be carried out by suitably qualified persons.

**If the engine still cannot be started, take your machine to an authorized dealer.**



# Maintenance

## ▲ Air Filter Service

**⚠ WARNING!** Never use petrol or low flash point solvents to clean the air cleaner element. This could result in a fire or explosion.

**⚠ CAUTION -** A dirty air filter will restrict the air flow to the carburettor, which will reduce engine efficiency. When using the machine in very dusty areas you must clean or replace the air filter more often. Never operate the machine without the air filter being fitted it can cause damage to the engine which is not covered by warranty.

- 1** Remove the wing nut and the air cleaner cover. Remove the elements and separate them. Carefully check the elements for holes and tears, and replace it if damaged.
- 2 Foam element:** Clean in warm soapy water and allow to dry thoroughly or clean in high flash point solvent and allow to dry. Dip the element in clean engine oil and squeeze out all the excess. The engine will smoke during initial start up if too much oil is left in the foam.
- 3 Paper element:** Tap the element lightly several times on a hard surface to remove excess dirt or blow compressed air through the filter from the inside out. Never try to brush the dirt off, doing so will force dirt into the fibers.



# Maintenance

## ▲ Spark Plug Service

**Recommended spark plug: BPR5ES (NGK) / F7RTC (LG).**

To ensure proper engine operation, the spark plug must be properly gapped and free of deposits.

### ⚠ **WARNING!**

If the engine has been running, the exhaust will be very hot. Be careful not to touch the exhaust.

- 1 Remove the spark plug cap (3.2).

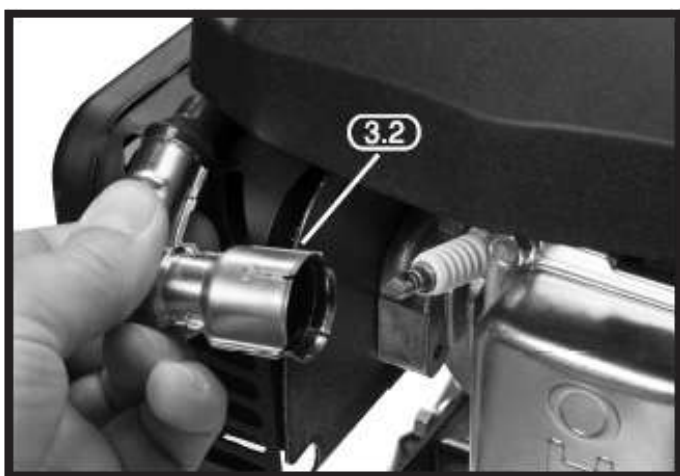

- 2 Visually inspect the spark plug. Discard it if the insulator is cracked or chipped.
- 3 Measure the plug gap with a feeler gauge. The gap should be 0.7-0.8mm. Correct as necessary by bending the side electrode.
- 4 Attach the plug washer, thread the plug in by hand to prevent cross-threading.
- 5 When mounting a new spark plug, you should screw 1/2 more thread with the wrench after the washer is compressed. If you are mounting an old one, you should only screw 1/8-1/4 more thread.

### ⚠ **CAUTION!**

The spark plug must be securely tightened. An improperly tightened plug can become very hot and possibly damage the engine. Never use a spark plug with an improper heat range.



# Maintenance

## ⚠ Draining The Oil

⚠ **NOTE** - Please dispose used motor oil in a manner that is compatible with the environment. The oil can be discharged at a specialised servicing centre, or by using a syringe to suction the oil out through the filler spout, bearing in mind you may need to repeat the operation several times in order to completely empty the tank. Do not throw it in the bin or pour on the ground.

Drain the oil while engine is still warm to assure rapid and complete drainage.

- 1 Remove the oil filler cap and drain the oil.
- 2 Refill with the recommended oil and check the level. Wash your hands with soap and water after touching used oil.

## ⚠ Adding Gearbox Oil

⚠ **NOTE** - The gearbox is pre-filled with oil.

- 1 Remove rotating blades (see attaching blades section).

Unscrew the gearbox oil filler bolt with a hexagon spanner, and remove it.

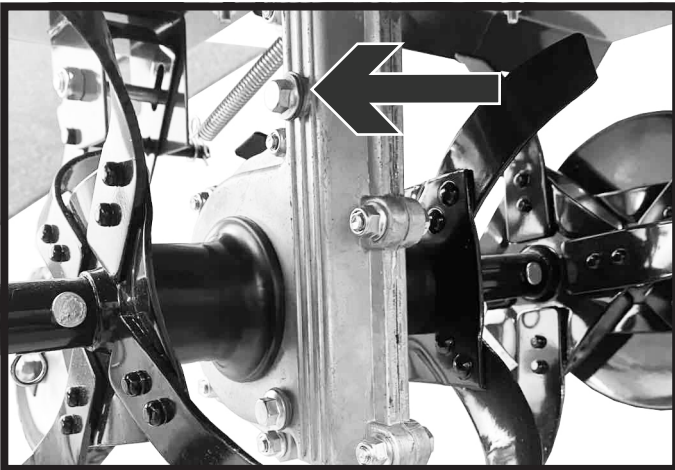

- 2 Ensure gearbox oil drain bolt is securely in position.
- 3 Use gearbox oil SAE 85W-90. Carefully pour in gearbox oil (approx.200ml). Avoid spilling.
- 4 Re-tighten the gearbox oil filling bolt.

# Maintenance

## ▲ Draining Gearbox Oil

- 1 Hold a collection container beneath the gearbox oil drain bolt.

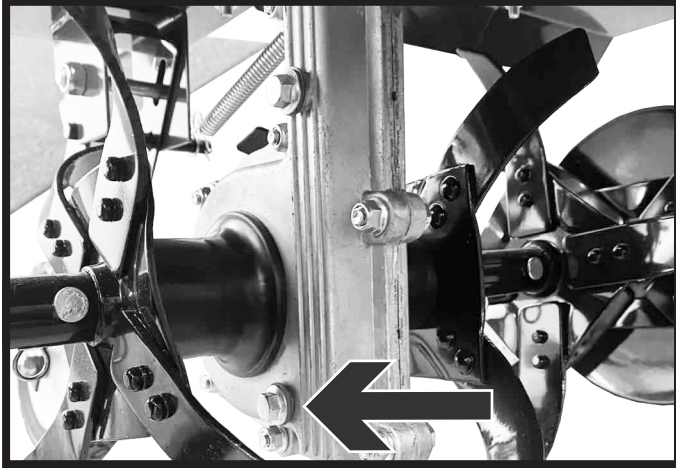

- 2 Unscrew the gearbox oil drain bolt and remove.
- 3 Allow the gearbox oil to run out completely.

# Maintenance

## Cleaning

 **CAUTION - DO NOT** use a hose pipe or pressure washer to clean the engine. Water can damage the engine or contaminate the fuel system.

 **NOTE** Engine must be switched off and spark plug lead disconnected.

- You must remove grass and mud from the machine to prevent it from drying. This will cause problems the next time the machine is used.
- Wipe the machine down with a damp cloth.
- For larger build ups of debris, use a scraper or similar product.
- Dry the machine completely to prevent rust from forming.
- Make sure not to drip petrol onto the plastic parts to prevent damaging them and remove all traces of spilt petrol immediately. The warranty will not cover damage to plastic parts caused by petrol.
- Use a light silicone spray on exposed metal parts to protect the metal.
- Avoid using solvents when cleaning plastic parts. Most plastics are susceptible to damage from various types of commercial solvents and may be damaged by their use.
- If not cleaned and maintained correctly or regularly, the machine will not perform at its best.



# Maintenance

## Transportation

Whenever the machine is to be handled, lifted, transported or tilted, you must:









- 1 When transporting the tiller, turn the fuel valve OFF and keep the tiller level to prevent fuel spillage. Fuel vapour or spilled fuel may be easily ignited.
- 2 Wear sturdy work gloves.
- 3 Hold the machine at the points that offer a safe grip, taking into account the weight and relative distribution of the same.
- 4 Use an appropriate number of people for the weight of the machine and the characteristics of the vehicle or the place where it must be placed or collected.
- 5 You must make sure that machine movements do not cause petrol leaks, damage or injuries.
- 6 During transport, make sure to fasten the machine securely with cables or straps.
- 7 The machine must be transported on a flat surface.
- 8 Care must be taken when handling and lifting. Dropping the machine will have an effect on the accuracy and may also result in personal injury. Be sure to transport the tiller from one place to another by two people, if a carrier is not available.



# Maintenance



## Storage

### Where To Store

-  Store in a cool, dry place away from sources of ignition and varying changes in temperature.
-  Store on a flat and level surface with all wheels on the ground.
-  DO NOT stack other items on top of the machine when in storage.
-  Store the machine in a safe place, out of the reach of children or anyone who is not familiar with operation.
-  To reduce fire hazards, keep the engine, silencer, and petrol storage area free of grass, leaves, or excessive grease. Do not leave containers full of cut grass inside storage areas.
-  DO NOT store the machine with fuel in the tank in an area where the fuel vapours could reach an open flame, a strong heat source or a spark.
-  DO NOT store a machine that has not been given time to fully cool down. Engine must be cooled down fully before storage.
-  Do not place the tiller with the handlebars on the ground. It will cause the oil entering the cylinder or fuel spillage.

### Short Term

After use, please follow the below steps before storing your machine.

-  1 Allow the engine to fully cool down.
-  2 Clean the machine. See the 'Cleaning' section.
-  3 Store the machine following the guidelines above.

If storing the machine for a period of 30 days or more, you must follow proper storage and winterisation guidelines to avoid any possible issues with the machine. Incorrect storage can lead to possible fueling or engine issues that will not be covered by the warranty.



# Maintenance

## Long Term

- 1 Allow the engine to fully cool down.
- 2 Drain the fuel.  
The fuel can be drained through the carburettor by removing the float bowl drain plug. Ensure you use a suitable fuel container to drain the petrol into. (This is a slow process, it is advisable to run the fuel level down as low as possible before draining).

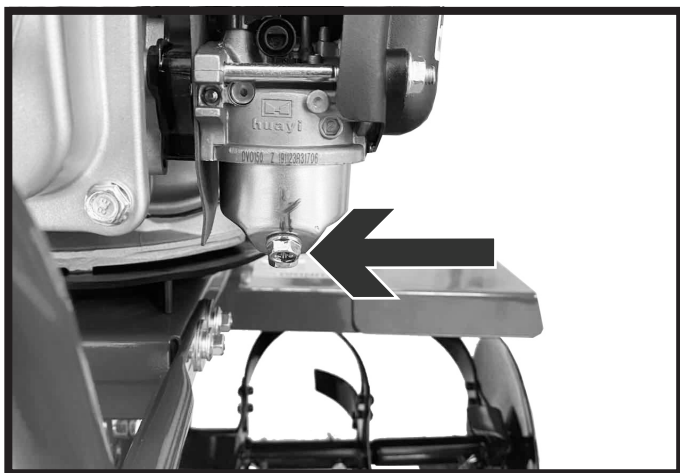

- 3 Follow the cleaning instructions in the 'Cleaning' section.
- 4 Follow the maintenance section and check, service or replace serviceable items if required. Visually inspect the machine and replace or repair any worn parts.
- 5 Make sure all moving parts are lubricated with a light silicone based spray or grease.
- 6 Drain and replace with new engine oil.
- 7 Remove the spark plug and pour 1 teaspoon of fresh engine oil down the cylinder bore. Cover the spark plug hole with a lint free clean cloth, ensuring no dirt or debris falls into the cylinder chamber and gently pull the recoil starter handle to coat the cylinder bore with the fresh oil. Refit the spark plug.

## Preparation To Re-Use

- 1 Check oil level before using.
- 2 Check spark plug is inserted correctly.
- 3 Fill engine with fresh unleaded petrol that has not been stored for periods of more than 30 days.



## Troubleshooting

Problem	Possible Cause	Possible Solution
Engine cannot be started	<ol style="list-style-type: none"> <li>1. Not enough fuel</li> <li>2. Fuel valve is OFF</li> <li>3. Engine switch is OFF</li> <li>4. Carburettor is blocked</li> <li>5. No spark from the spark plug</li> </ol>	<ol style="list-style-type: none"> <li>1. Check fuel level in fuel tank</li> <li>2. Open the fuel valve</li> <li>3. Turn the engine switch ON</li> <li>4. Loosen the drain knob with the fuel valve ON. Fuel can flow out freely and then re-tighten drain knob</li> <li>5. Remove and clean the spark plug</li> </ol>
Clutch not working	<ol style="list-style-type: none"> <li>1. Engine speed is low</li> <li>2. Belt too long</li> <li>3. Spring failure</li> <li>4. Bearing inside gearbox failure</li> </ol>	<ol style="list-style-type: none"> <li>1. Open throttle, increase engine speed</li> <li>2. Replace</li> <li>3. Replace</li> <li>4. Replace</li> </ol>
Sliding	<ol style="list-style-type: none"> <li>1. Spring/belt failure</li> </ol>	<ol style="list-style-type: none"> <li>1. Replace</li> </ol>
Abnormal noise from gears	<ol style="list-style-type: none"> <li>1. Loose bearing</li> <li>2. Drive shaft deformed</li> <li>3. Gears wear out</li> </ol>	<ol style="list-style-type: none"> <li>1. Replace</li> <li>2. Replace</li> <li>3. Replace</li> </ol>
Oil leakage	<ol style="list-style-type: none"> <li>1. O type sealing failure</li> <li>2. Loose bolts</li> </ol>	<ol style="list-style-type: none"> <li>1. Replace</li> <li>2. Tighten</li> </ol>

**If the engine still cannot be started, take your machine to an authorized dealer.**

 **CAUTION!** For your own safety, turn the tiller off before any maintenance.

 **NOTE** - Where necessary, all corrective actions should be carried out by suitably qualified person.

# Technical Data

## Specifications

Model	HYT150
Engine Type	HYUNDAI IC150V 4-stroke OHV
Engine Size	150cc
Rated power	2.7kW
Engine Speed	3000rpm
Fuel Tank Capacity	0.8L
Fuel Type	Unleaded Petrol
Oil Tank Capacity	0.4L
Oil Type	SAE30 or 15w40 engine oil
Tilling Width	560mm
Tilling Depth	130mm
Sound Pressure Level	69.16dB(A)
Sound Power Level	93dB(A)
Vibration Value	Left handlebar 11.06m/s <sup>2</sup> Right handlebar 7.72m/s <sup>2</sup>
Net Weight	29.5kg
Dimensions (L x W x H)	1350mm x 605mm x 1100mm

## Spare Parts

Only use original spare parts: The use of non-original and/or incorrectly fitted parts will jeopardize the safety of the machine, may cause accidents or personal injuries for which the Manufacturer is under no circumstance liable or responsible.

Part	Part Number
Blade	HYT150BLADE
Recoil	HYT150RECOIL
Front Wheel	HYT150WHEEL



# Recycling And Disposal

## Recycling And Disposal



We do not offer a takeback scheme for the recovery of Waste Electrical Electronic Equipment (WEEE) & Batteries. Instead the responsibility to dispose of WEEE and/or Batteries is passed onto you by us.

So when it becomes necessary to dispose of your machine you must take it to your local Civic Amenity Site. For further information please contact your local Authority for disposal advice.

You **MUST** make sure that all unused oil and fuel is disposed of correctly either beforehand or at your local Civic Amenity Site.

- Under NO circumstances must any fuel or oil be put down any drains.
- Certain products contain WEEE waste which should not be disposed of in your domestic waste.
- You **MUST** recycle WEEE in accordance with your local authority or recycling centre.
- Certain products contain batteries which should not be disposed of in your domestic waste.
- You **MUST** recycle batteries in accordance with your local authority or recycling centre.
- Unwanted packaging and materials should be stored and taken to a recycling centre so it can be disposed of in a manner which is compatible with the environment.

We are a Member of the VALPAK National Compliance Scheme and our registration number is **RM08660**. For further information about disposal please contact your Local Authority.

You can also get more advice and guidance about recycling at the following website  
<http://www.recycle-more.co.uk>

Should you pass this product on to another user either sold or loaned, you **MUST** pass on this user manual. This will make sure that all other users can use and maintain this machine safely.

## Environmental Protection

1. Environmental protection should be a priority of considerable importance when using the machine, for the benefit of both social coexistence and the environment in which we live. Try not to cause any disturbance to the surrounding area.
2. You must comply with local regulations and provisions for the disposal of packaging, oils, petrol, filters, damaged parts or any elements which have a strong impact on the environment. This waste must not be disposed of as normal waste. It needs to be separated and taken to specified waste disposal centres where the material will be recycled.
3. You must comply with local regulations for the disposal of waste materials after mowing.
4. When disposing, do not pollute the environment with the machine, but hand it over to a disposal centre, in accordance with the local laws in force.



# Declaration Of Conformity

## EC Declaration of Conformity

We hereby declare that the machine detailed in this declaration complies to all the relevant provisions of the following EC directives.

- 2006/42/EC The Machinery Directive
- 2014/30/EU Annex II Electromagnetic Compatibility Directive
- 2016/1628/EC The Emission of Gaseous and Particulate Pollutants from internal Combustion engines
- 2000/14/EC Noise Emissions in the Environment by Equipment for use Outdoors.

And is in conformity with the applicable requirements of the following documents:

- EN ISO 3744:1995
- EN ISO 11094:1991
- EN ISO 5395-1:2013
- EN ISO 5395-2: 2013
- EN ISO 14982:2009

Declaration for 2000/14/EC Noise Emissions in the Environment by Equipment for use Outdoors.

Notified Body for EC Directive 2000/14/EC TÜV Rheinland (Shanghai) Co., Ltd.

Model	Type	Cutting Width	Measured Sound Power	Guaranteed Sound Power	Engine Speed (rpm)
HYT150	Petrol rotovator	560mm	91.31dB(A)	93dB(A)	2790

### Product Details

Brand: Hyundai

Model: HYT150

Description: Petrol rotovator

### Name and address of technical documentation holder and EU distributor:

Genpower Ltd, Isaac Way, Pembroke Dock, Pembrokeshire, SA72 4RW, UK.

Signed by:  Roland Llewellyn, Managing Director

Date: 04/03/2020







# Useful Information

## Check Out Our YouTube Channel

Our videos on YouTube include:

- Unboxing
- Assembly of your machine
- How to service your machine
- Products in use
- 'How To' videos
- Product features

Go to [www.hyundaisupport.co.uk](http://www.hyundaisupport.co.uk) or search 'Hyundai Power Products' in YouTube.

## Warranty

Proof of purchase will be required before you make a warranty claim.

Full warranty terms and conditions can be found on the HYUNDAI POWER PRODUCTS website: [www.hyundaipowerproducts.co.uk](http://www.hyundaipowerproducts.co.uk)

## Manual Updates

Our manuals are constantly being reviewed and updated. Should you find an error, omission or something unclear, please contact us for assistance.

We reserve the right to make any modifications without prior notice whenever necessary.

Our latest manuals are also placed online.

All our manuals can be downloaded at: [www.hyundaipowerproducts.co.uk](http://www.hyundaipowerproducts.co.uk)

## Returning Your Product

If you are returning your product, please contact the dealer for their returns policy.

## Leaving A Review

We work very hard to give all of our customers the best possible service. If you have any problems, before leaving negative feedback, please contact us to give us a chance to resolve the issue. We would be delighted if you left us positive feedback!

To leave a review, please go to: [uk.trustpilot.com/review/hyundaipowerequipment.co.uk](http://uk.trustpilot.com/review/hyundaipowerequipment.co.uk)

## Ordering Spare Parts

Only use original spare parts: The use of non-original and/or incorrectly fitted parts will jeopardise the safety of the machine, may cause accidents or personal injuries for which the manufacturer is under no circumstance liable or responsible.





# Our Product Range

## Generators

Leisure Inverter, Petrol, Diesel And Built-In Motorhome Generators

## Pressure Washers

Petrol, Diesel And Electric Pressure Washers

## Water Pumps

Submersible, Clean And Dirty Water And Professional Chemical Water Pumps

## Lawnmowers

Petrol, Cordless, Electric, Roller, Self Propelled, Electric Start And Robotic Lawnmowers

## Grass Trimmers And Brush Cutters

Petrol, Cordless, Electric And Wheeled Grass Trimmers And Brush Cutters

## Chainsaws

Petrol, Cordless And Electric Chainsaws

## Hedge Trimmers

Petrol And Cordless Hedge Trimmers

## Leaf Blowers

Petrol, Electric, Cordless, Backpack And 3 -in-1 Leaf Blowers

## Log Splitters

Horizontal, Vertical, Petrol And Electric Log Splitters

## Wood Chippers

Petrol And Electric Start Wood Chippers

## Tillers

Petrol Garden Tiller And Cultivator

## Earth Augers And Trenchers

Petrol Earth Augers And Heavy Duty Trenchers

## Compactor Plates

Petrol Compactor Plates

## Cement Mixers

Portable Electric Cement Mixers

## Mini Dumpers

4-Wheel Drive Mini Dumpers And Tracked Dumpers

## Yard Sweeper

Self Propelled Yard Sweeper Power Brush

## Scarifiers

Petrol Lawn Scarifier And Aerator

## Stump Grinders

Petrol 4-Stroke Stump Grinders

## Welders And Plasma Cutters

MIG, TIG, MMA, ARC Welders And Plasma Cutters

## Power Tools And Tool Chests

Electric And Cordless Power Tools And Filled Tool Chests

## Vacuum Cleaners

Wet And Dry Vacuum Cleaners

## Engines

Petrol And Electric Start Engines

## Battery Chargers / Starters

6V, 12V, 24V Battery Chargers, Jump Starters And Hydraulic Floor Jack

## Air Compressors

Home, Domestic, DIY And Professional Use Air Compressors

## Lighting Towers

Mobile Lighting Towers With Diesel Generators

## Portable Power Stations

Camping Power Packs And Solar Chargers

## And More

We Are Constantly Expanding Our Range With New Products

If you would like more information on any of these products, please contact our sales team on 01646 687880 or visit our website [www.hyundaipowerproducts.co.uk](http://www.hyundaipowerproducts.co.uk)



# Product Information

## Information

As soon as you have purchased the machine, we recommend that you fill out the following. If you need to contact an authorised dealer or customer service for information on servicing, you may need to provide the following information.

The model number and serial number can be found on the grey specification sticker on your machine.

Date Of Purchase: .....

Dealer Name:.....

Dealer Phone:.....

Model Number:.....

Serial Number:.....

## Service Record

### 1st Service

Date Of Service.....

Next Service Due.....

### 2nd Service

Date Of Service.....

Next Service Due.....

### 3rd Service

Date Of Service.....

Next Service Due.....

### 4th Service

Date Of Service.....

Next Service Due.....



# Need Help? Talk To Our Experts

## Contact Us

Our friendly aftersales team will be more than happy to help you.

 **Phone**

Call our team on 01646 687880, open Monday-Friday 8.30am-5pm.

 **Email**

[aftersales@hyundaipowerproducts.co.uk](mailto:aftersales@hyundaipowerproducts.co.uk)

 **Online Live Chat**

Go to [www.hyundaipowerproducts.co.uk](http://www.hyundaipowerproducts.co.uk)

Live chat is open Monday-Friday from 8.30am-5pm.

 **Post**

Genpower Limited, Isaac Way, Pembroke Dock, Pembrokeshire, SA72 4RW, UK.



# HYUNDAI

POWER PRODUCTS

Importer:  
GENPOWER LTD  
Isaac Way, London Road,  
Pembroke Dock, UNITED KINGDOM, SA72 4RW  
T: +44 (0) 1646 687 880 F: +44 (0) 1646 686 198  
E: [info@hyundaipowerproducts.co.uk](mailto:info@hyundaipowerproducts.co.uk)  
[www.hyundaipowerproducts.co.uk](http://www.hyundaipowerproducts.co.uk)

Imported/Distributed by Genpower Ltd for The United Kingdom & Ireland

Licensed by Hyundai Corporation, Korea